

29388

Dimensions

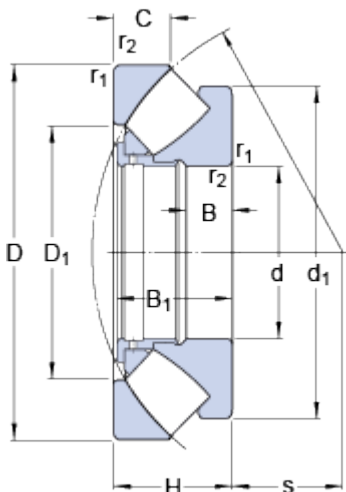

d	440	mm
D	680	mm
H	145	mm
d ₁	≈ 626	mm
D ₁	≈ 540	mm
B	49	mm
B ₁	140	mm
C	70.5	mm
s	249	mm
r _{1,2}	min. 6	mm

Abutment dimensions

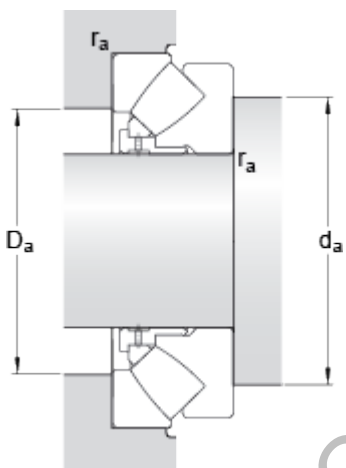

d _a	min. 560	mm
D _a	max. 605	mm
r _a	max. 5	mm

Calculation data

Basic dynamic load rating	C	5200	kN
Basic static load rating	C ₀	19300	kN
Fatigue load limit	P _u	1560	kN
Reference speed		530	r/min
Limiting speed		850	r/min
Minimum axial load factor	A	34	

Mass

Mass bearing		180	kg
--------------	--	-----	----